

Three-terminal positive voltage regulator

FEATURES

- Maximum output current IOM: 0.5 A
- Output voltage VO: 5V
- Continuous total dissipation
PD: 1.5 W (T_a= 25 °C)

MECHANICAL DAT

- Case: TO-220L Plastic Package
- Polarity: Color band denotes cathode end
- Mounting Position: Any

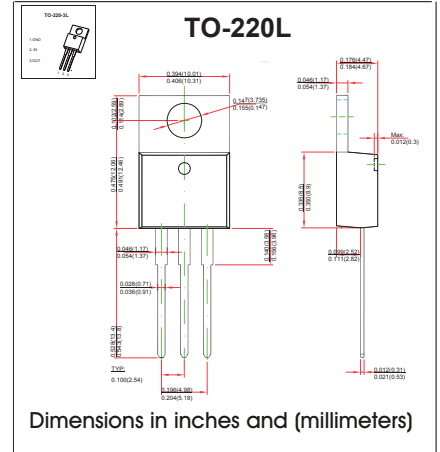

MAXIMUM RATINGS AND CHARACTERISTICS

@ 25°C Ambient Temperature (unless otherwise noted)

Parameter	Symbol	Value	Unit
Input Voltage	V _i	35	V
Thermal Resistance from Junction to Ambient	R _{θJA}	66.7	°C/W
Operating Junction Temperature Range	T _{OPR}	-25~+125	°C
Storage Temperature Range	T _{STG}	-65~+150	°C

ELECTRICAL CHARACTERISTICS AT SPECIFIED VIRTUAL JUNCTION TEMPERATURE (V_i=10V, I_o=350mA, C_i=0.33μF, C_o=0.1μF, unless otherwise specified)

Parameter	Symbol	Test conditions	Min	Typ	Max	Unit
Output Voltage	V _o	25°C	4.8	5	5.2	V
		7V ≤ V _i ≤ 20V, I _o = 5mA-350mA	-25~125°C	4.75	5	5.25
Load Regulation	ΔV _o	I _o = 5mA-0.5A	25°C	15	100	mV
		I _o = 5mA-200mA	25°C	5	50	mV
Line Regulation	ΔV _o	7V ≤ V _i ≤ 25V, I _o = 200mA	25°C	3	100	mV
		8V ≤ V _i ≤ 25V, I _o = 200mA	25°C	1	50	mV
Quiescent Current	I _q	25°C		4.2	6	mA
Quiescent Current Change	ΔI _q	8V ≤ V _i ≤ 25V, I _o = 200mA	-25~125°C		0.8	mA
		5mA ≤ I _o ≤ 350mA	-25~125°C		0.5	mA
Output Noise Voltage	V _N	10Hz ≤ f ≤ 100KHz	25°C	40	200	μV/V _o
Ripple Rejection	RR	8V ≤ V _i ≤ 18V, f = 120Hz, I _o = 300mA	-25~125°C	62	80	dB
Dropout Voltage	V _d	I _o = 350mA	25°C	2	2.5	V
Short Circuit Current	I _{sc}	V _i = 10V	25°C	300		mA
Peak Current	I _{pk}	25°C		0.5		A

* Pulse test.

TYPICAL APPLICATION

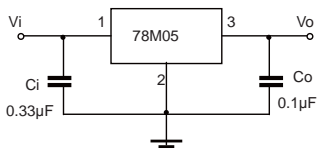

Note: Bypass capacitors are recommended for optimum stability and transient response and should be located as close as possible to the regulators

TYPICAL APPLICATION

Output Characteristics

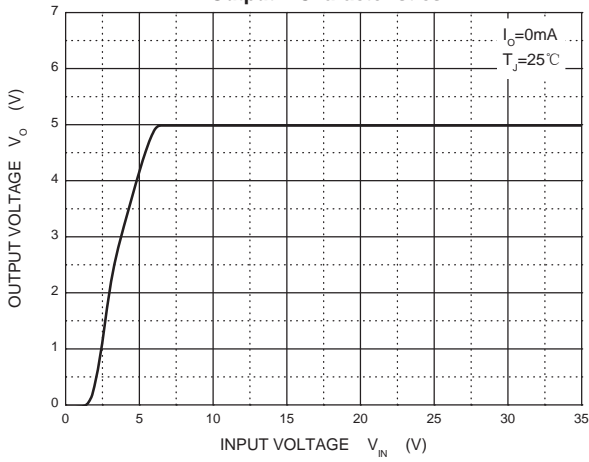

Dropout Characteristics

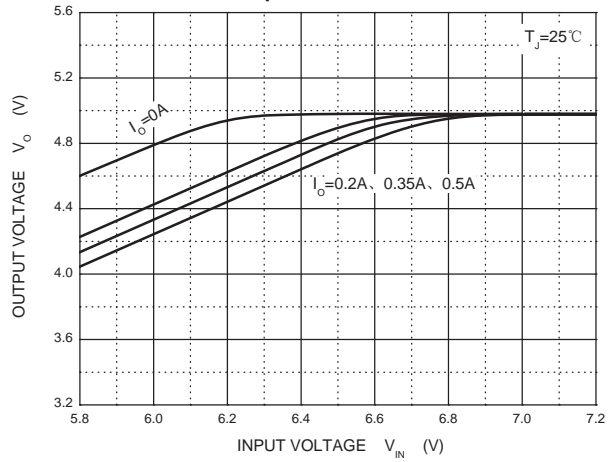

Quiescent Current

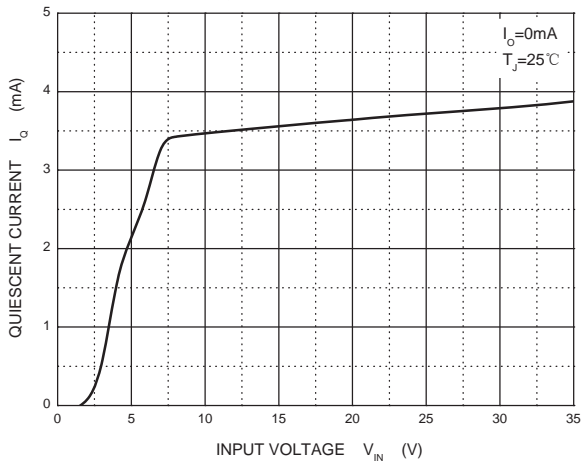

Current Cut-off Grid Voltage

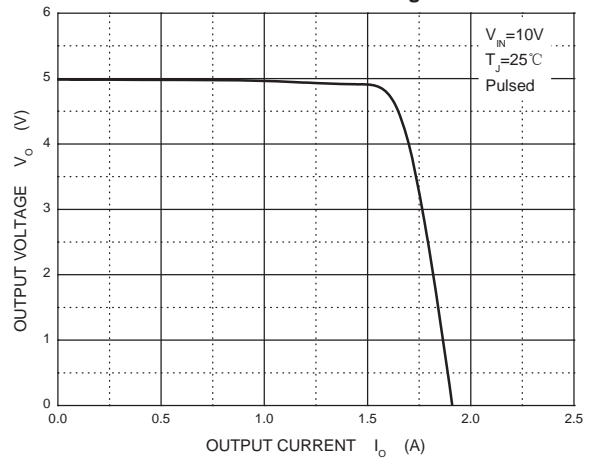

Output Voltage vs Junction Temperature

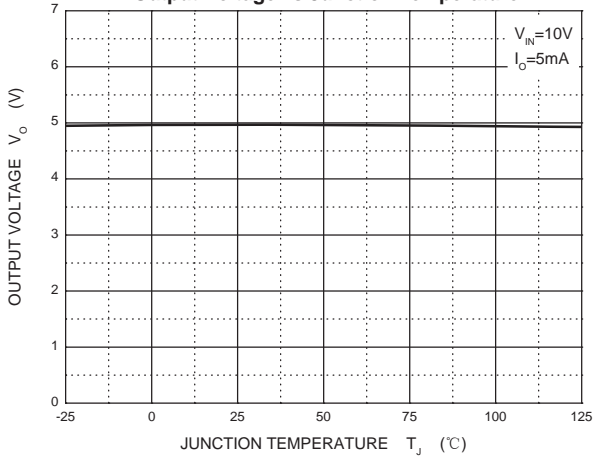

Power Derating Curve

